

Scanning Probe Microscope

# SPM-9700HT

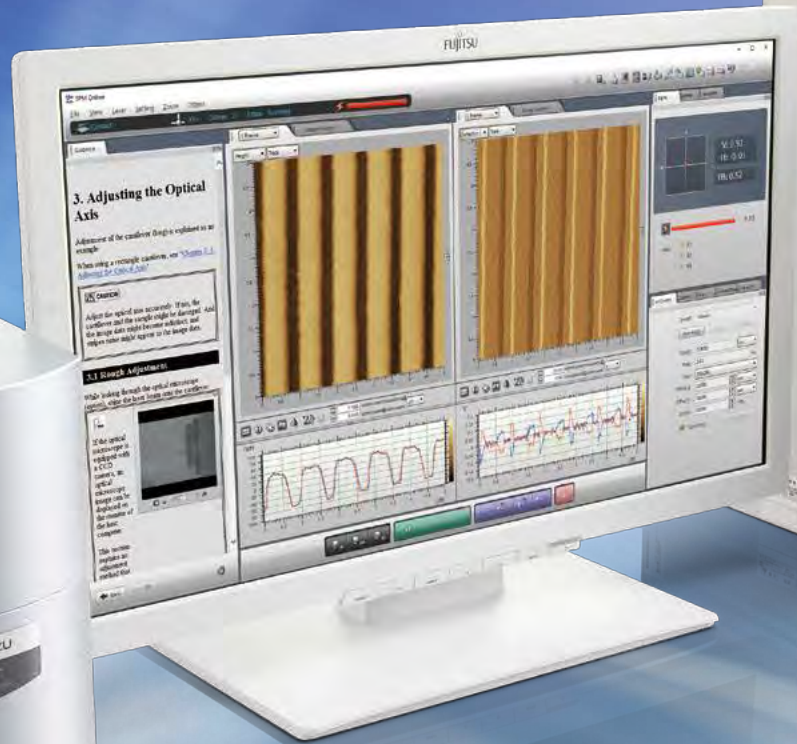



## Scanning Probe Microscope **SPM-9700HT**

# Making the Unknown Visible

Scanning probe microscope (SPM) is a generic term for microscopes that scan sample surfaces with an extremely sharp probe to observe their three-dimensional image or local properties at high magnifications.

The SPM-9700HT takes high-throughput observations to the next level.



Functionality and Expandability to Meet a Wide Variety of Requirements P. 4

**HT** Head-Slide Mechanism — High Stability P. 6

**HT** HT Scanner P. 8

**HT** CantileverMaster P. 9

**HT** Ease of Operation Minimizes Distraction from Observation to Analysis P. 10

Nano 3D mapping to visualize the physical properties  
of nanoregion surfaces and interfaces P. 12

Wide Variety of 3D Rendering Functions  
Using Mouse Operations P. 14

Particle Analysis Software P. 15

SPM Data Room Website P. 16

SPM Unit P. 18

WET-SPM Series P. 20

WET-SPM Series Options P. 22

Specifications P. 24

Installation Specifications P. 25

# Functionality and Expandability to Meet a Wide Range of Requirements

■ indicates standard specification. □ indicates optional specification.

Other special orders are also accepted. For more information, contact your Shimadzu representative.

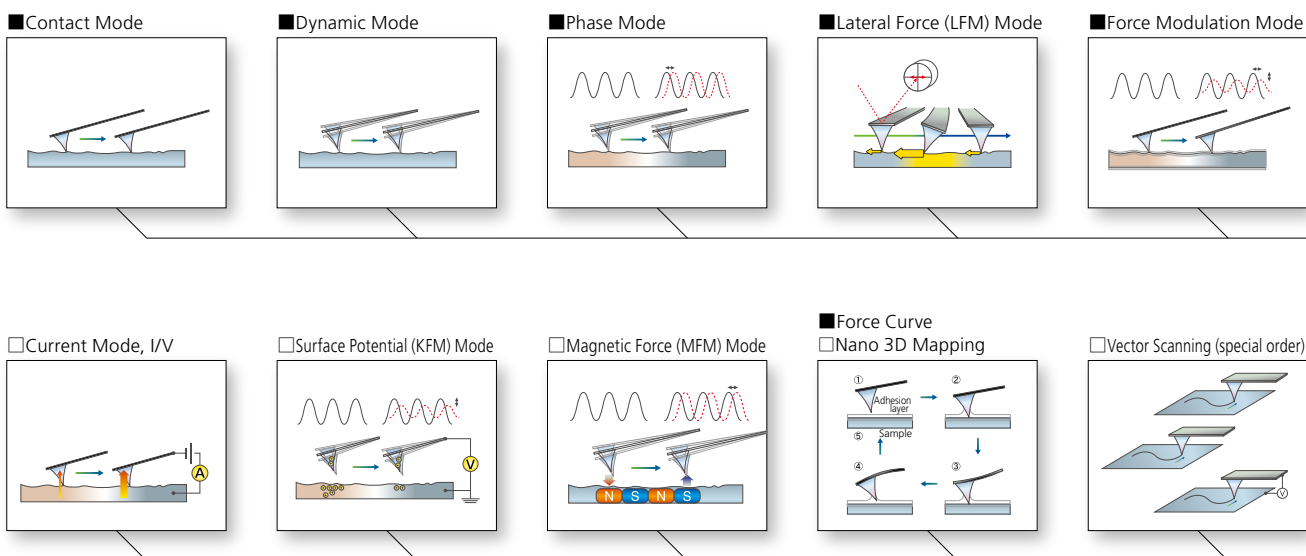

HT Scanner Unit  
(10 $\mu$ m Scanner)



Mid-range scanner  
(30 $\mu$ m Scanner)



Wide Range Scanner Unit  
(125 $\mu$ m Scanner)



Deep-Type Scanner Unit  
(55 $\mu$ m Scanner)



Narrow Range Scanner Unit  
(2.5 $\mu$ m Scanner)



Petri Dish Type Solution Cell (Special order)



Electrochemical Solution Cell



High Magnification Optical  
Microscope Unit



Optical Microscope Unit  
with CCD



Optical Microscope Unit



Fiber Light



Particle Analysis  
Software

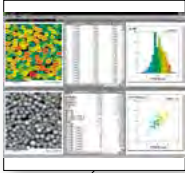

Desk-Type Air-Spring  
Vibration Damper



Active Vibration Damper  
 Active Vibration Damper with a Stand



Cantilever mounting jig



Static Eliminator



Environment Controlled Chamber CH-II (without TMP)  
 Environment Controlled Chamber CH-III (with TMP)



Computer Table



Sample Heating Unit



Light Irradiation Unit



LED Transmitted Illumination Kit, Model S  
 LED Transmitted Illumination Kit, Model L



Temperature and  
Humidity Controller



Sample Heating and  
Cooling Unit



Gas Spray Unit

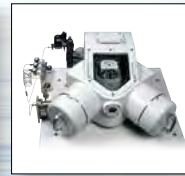

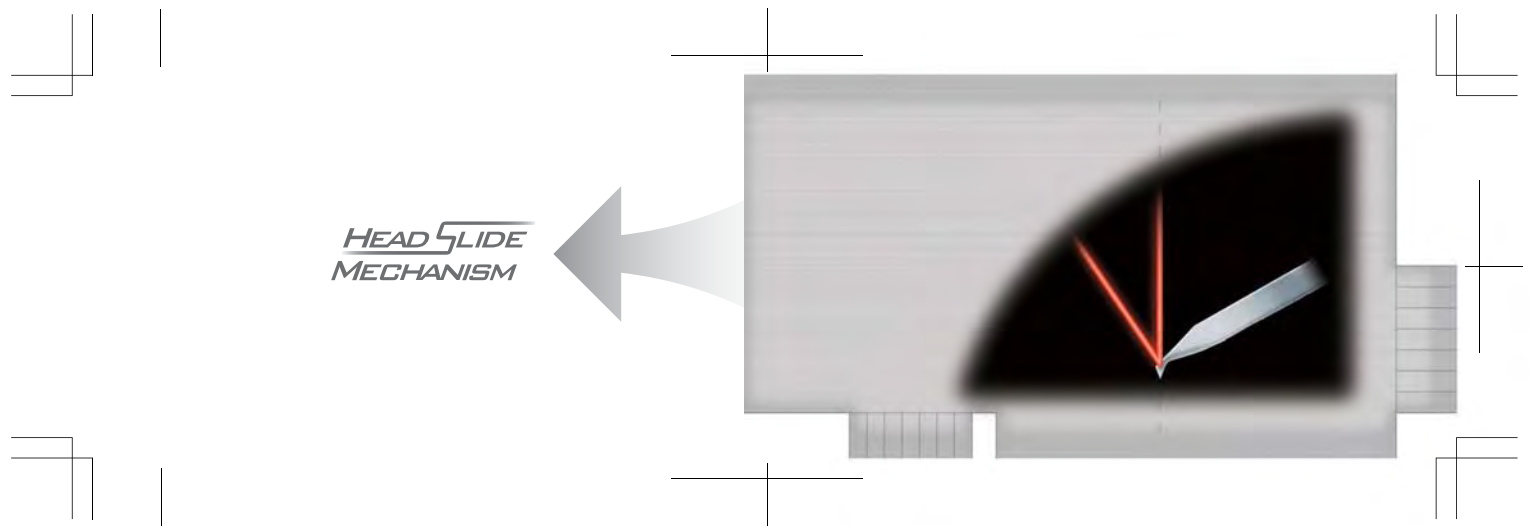
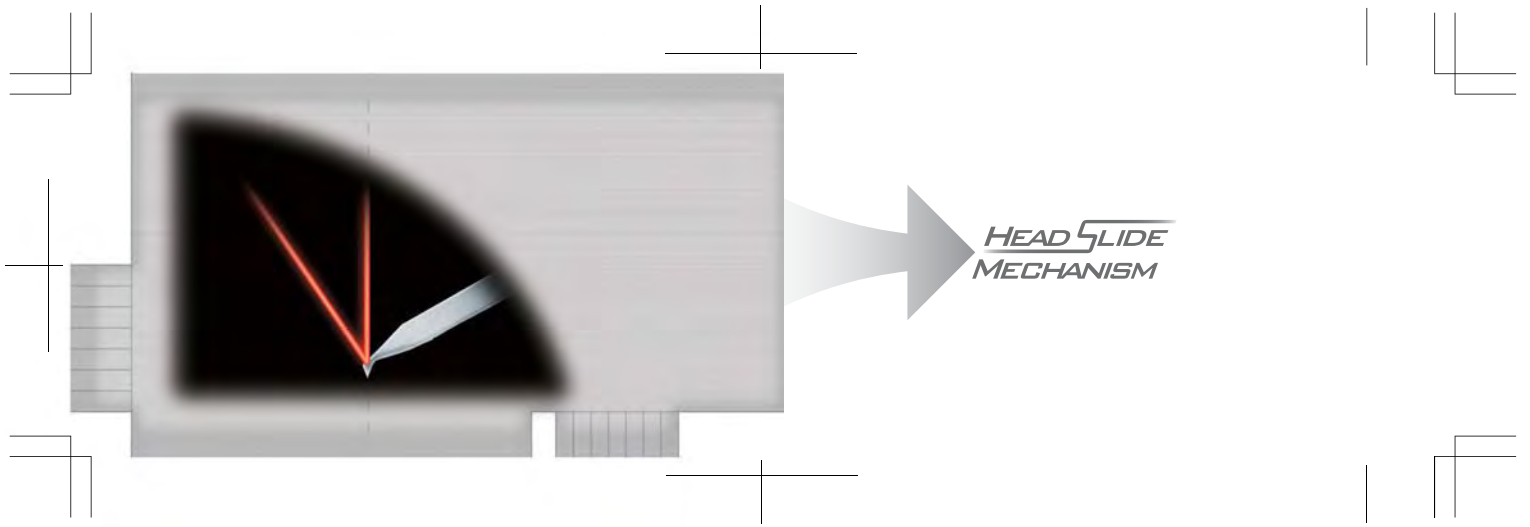

# Head-Slide Mechanism — High Stability



Allows Sliding the Entire Optical Lever System as a Single Unit, While Maintaining High Rigidity.

- The laser remains stable and irradiates the cantilever even while replacing samples.
- Design is resistant to vibration, noise, wind, and other external disturbances, so a specialized enclosure is not necessary.
- The main unit includes a built-in vibration isolator.

Right Side View (actual size)

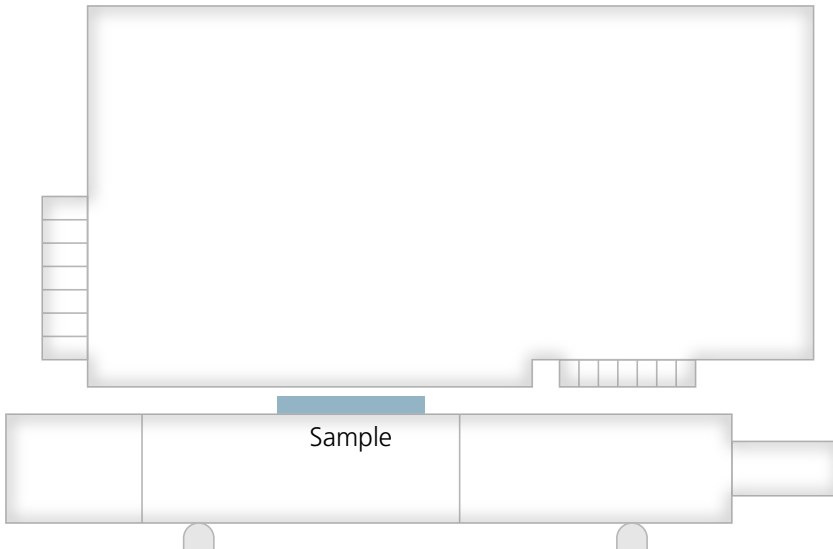

## Secret to the High Stability of the SPM-9700HT

Remarkable Mechanism Maintains High Performance  
—Comparison of Stability for Different Laser Irradiation—

SPM-9700HT

Laser Irradiated **Continuously**

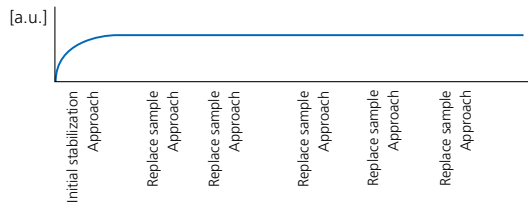

System Without Head-Slide Mechanism  
(one example)

Laser Irradiated **Intermittently**

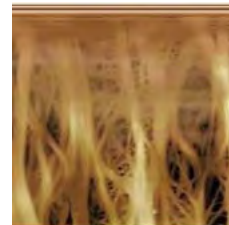
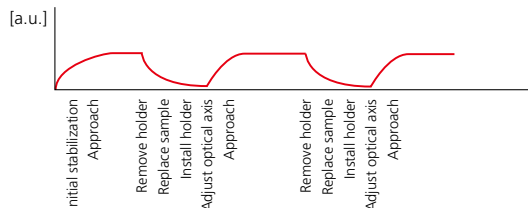



# Head-Slide Mechanism — High Throughput

Successfully Opened Up the Area Around the Sample While Maintaining High Rigidity

- Samples can be replaced without removing the cantilever holder.
- Samples can be accessed even during SPM observation.
- Samples are approached automatically, regardless of the sample thickness.

(Japanese Patent No. 2833491)

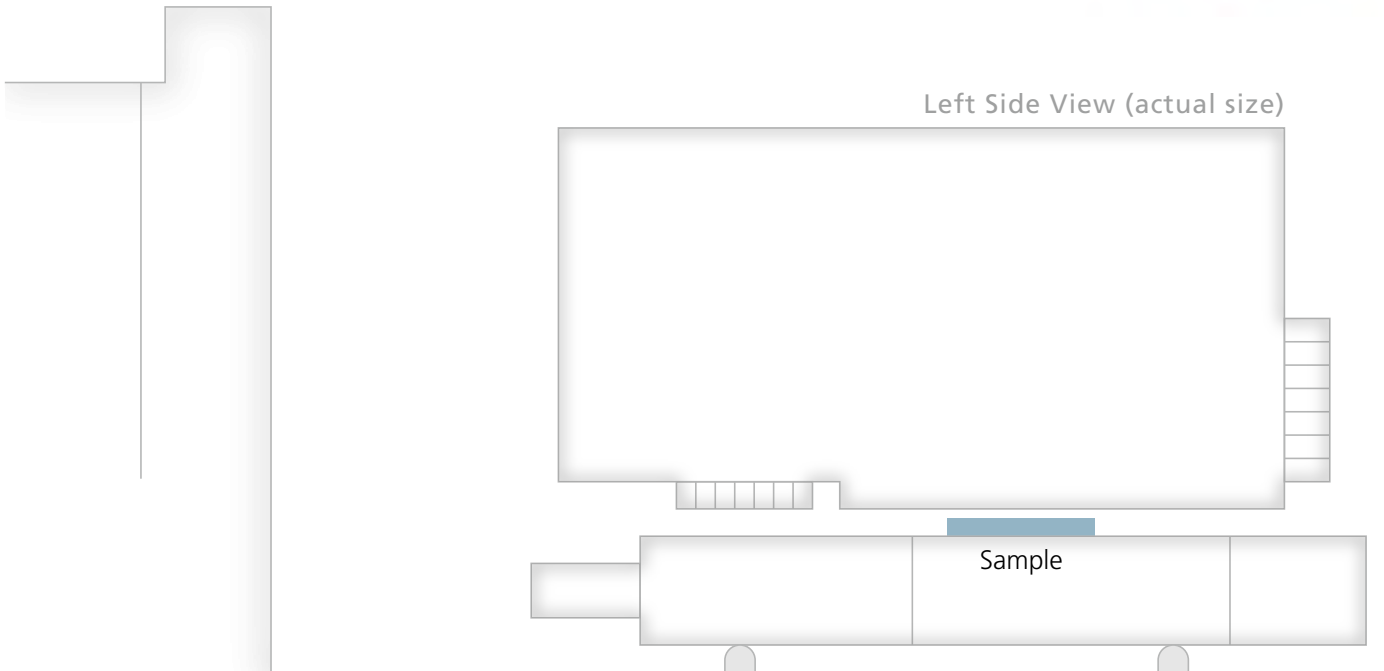

## Secret to the High Throughput of the SPM-9700HT

Remarkable Mechanism Optimized for Ease of Operation

—Comparison of Throughput for Differences in Replacing Samples—

### SPM-9700HT

Samples Replaced by **Sliding** the Head

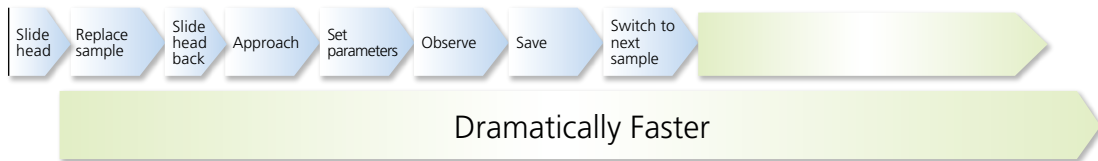

### System Without Head-Slide Mechanism (one example)

Samples Replaced by **Disassembling** the Head

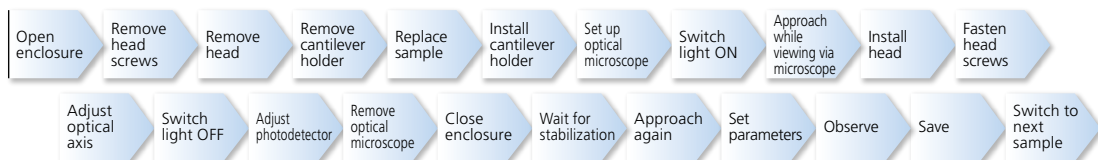



# High-Throughput Scanner Shortens Observation Times

Due to the new developed HT scanner that achieves a high-speed response and optimizing softwares and the design of control system, acquisition of the image data is now available at a speed of conventional than 5 times or more (our ratio).

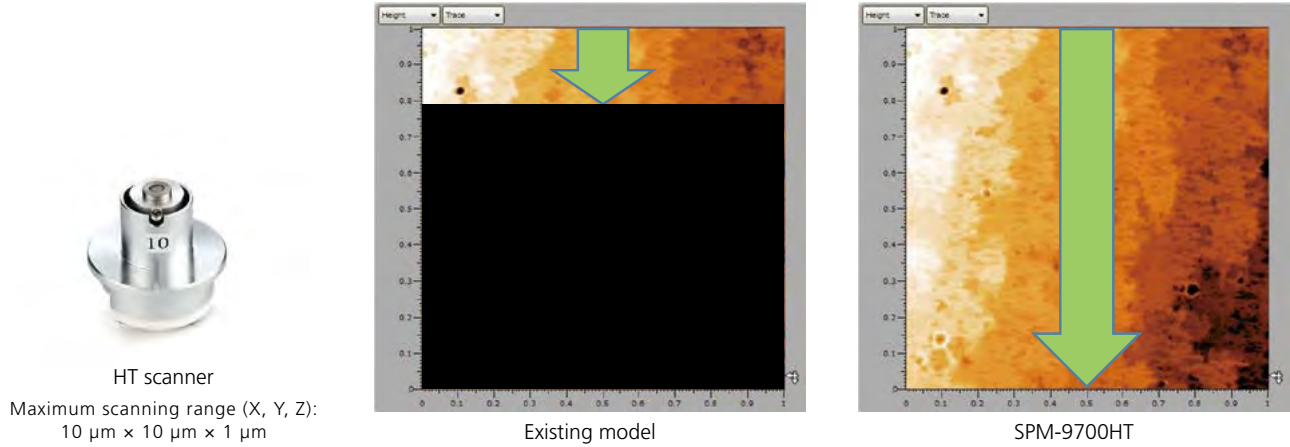

The scanner can easily be replaced so existing scanners can be used. The HT scanner can also be added to an existing SPM-9700 unit to enable high-throughput observation.

## Analysis Example

- Surface Roughness Analysis of a Vapor-Deposited Metal Film

The surface topology of a vapor-deposited metal film was observed using a scanning rate of 1 Hz and 5 Hz. Image quality and surface roughness analysis results are equivalent.

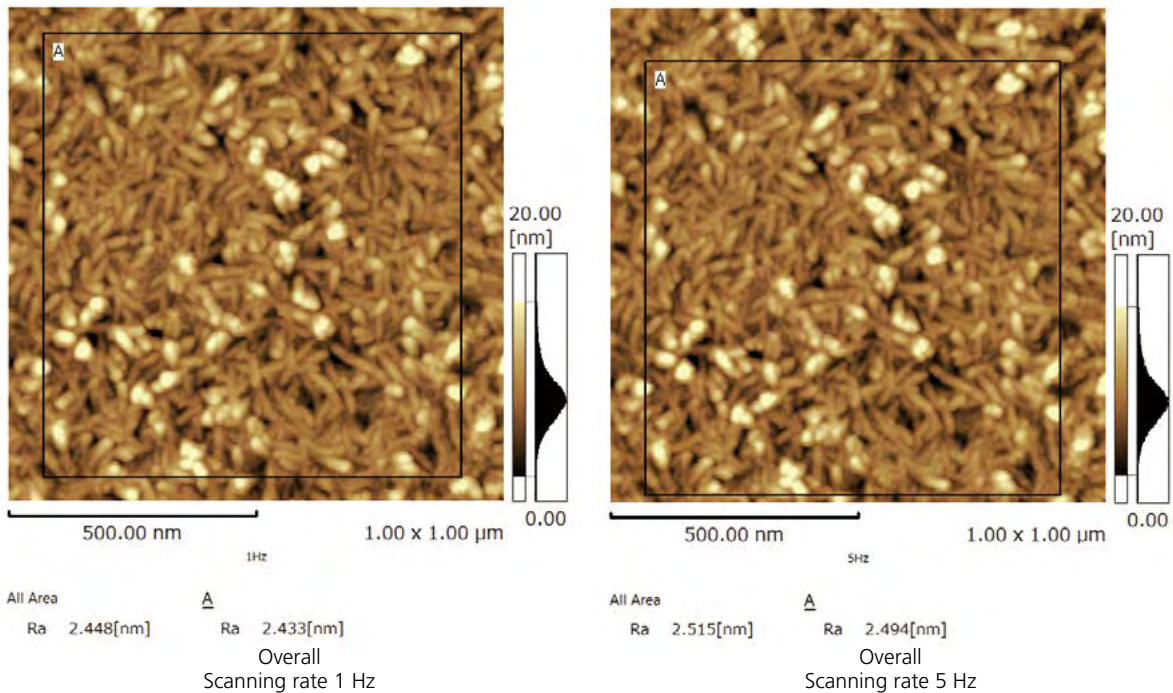

- Grating Surface Topology Measurement

The grating surface topology was observed at a scanning rate of 1 Hz and 5 Hz. The measurement by cross-section profile analysis shows that both give the same results.

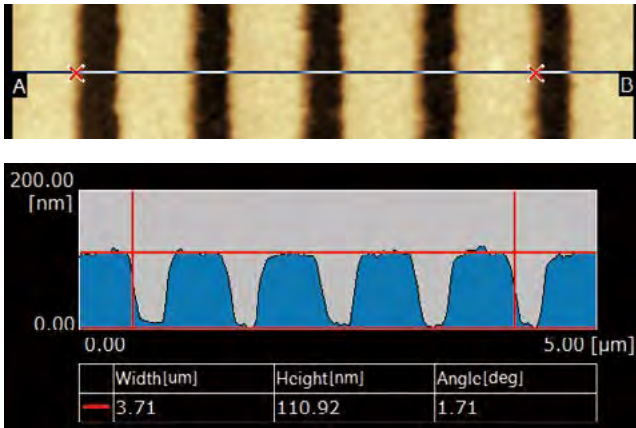

Scanning rate 1 Hz

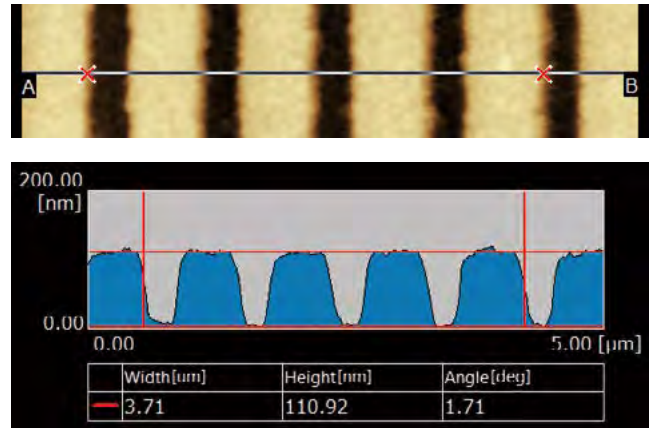

Scanning rate 5 Hz



## CantileverMaster Cantilever Mounting Jig (option)

This jig ensures easy and secure mounting of the cantilever.

Mounting procedure:

- (1) Set the cantilever holder in the cantilever mounting jig.
- (2) Place the cantilever on the slide.
- (3) Slide the the cantilever onto the cantilever holder, and secure it.

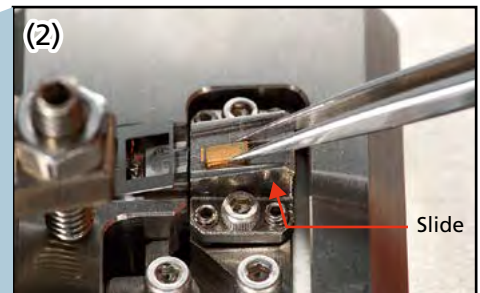

# Ease of Operation Minimizes Distraction from Observation to Analysis

A revolutionary layout-free graphical user interface (GUI) provides borderless support for operations ranging from online observation to offline analysis. This means the SPM can be operated from observation to analysis without confusion.



## Operate Without Confusion

From startup to observation and analysis, the SPM can be operated using only mouse clicks; no complicated settings are required



### 1 Startup

Select the observation mode in the manager window.

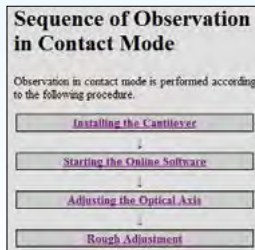

### 2 Setup

Follow the steps indicated in the guidance window to easily complete setup.

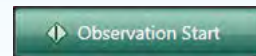

### 3 Start Observation

Clicking the [Observation Start] button performs all operations automatically, from approach to observation.

## Determine the Observation Position Without Confusion

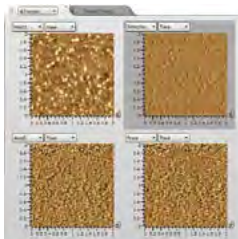

### 1 Observation Window

Up to 8 images can be displayed simultaneously. This means the surface shape and physical properties can be compared in multiple images, while scanning.



### 2 Navigator

The Navigator allows freely navigating from a broad area to any specific area desired. Saved image data can be displayed as reference as well.

## Obtain Observation Results Without Confusion

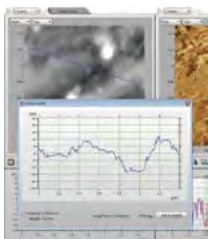

### 3 Online Profile

Cross-section profiles can be measured in the online window while observing samples.

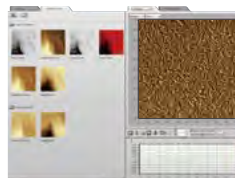

### 4 Image History

Past image data can be displayed next to current observation images for comparison.

## Wide Assortment of Scanning Functions

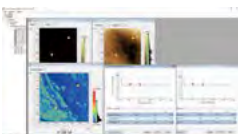

### 5 Nano 3D Mapping (option)

A force curve can be measured for each point in observed image data to acquire a distribution of sample mechanical properties or adhesion force.



### 6 Vector Scanning (special order)

The scanning direction, force between the probe and sample, or the applied voltage can be programmed to allow scanning according to a program.



### 4 Display

Image data observed in the past can be viewed without switching offline.

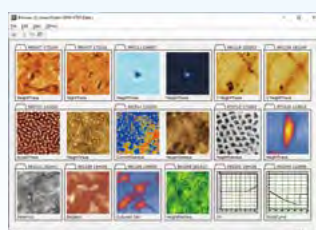

### 5 Offline Analysis

A wide selection of functions for displaying, processing, and analyzing images are available for expressing observation results more attractively and quantitatively.

Improved Usability!

# Visualizing the Physical Properties of Nano-Regions on Surface or Interface

The physical properties of external or boundary surfaces can be evaluated by measuring the force acting on a scanning probe microscope cantilever probe as its distance from the sample is varied (force curve measurement).

## Key Features

- 1 The adhesive force and Young's modulus can be evaluated at a specific target location by measuring the force curve at that point (point analysis).
- 2 By acquiring force curves at multiple points, a two-dimension map of the physical properties can be created (mapping analysis).
- 3 Acquired data can be displayed three-dimensionally, or specific data can be extracted for data analysis (3D analysis).
- 4 Quantitative Young's modulus values can be calculated from a theoretical model.

## Evaluating Physical Properties at Any Point on a Film

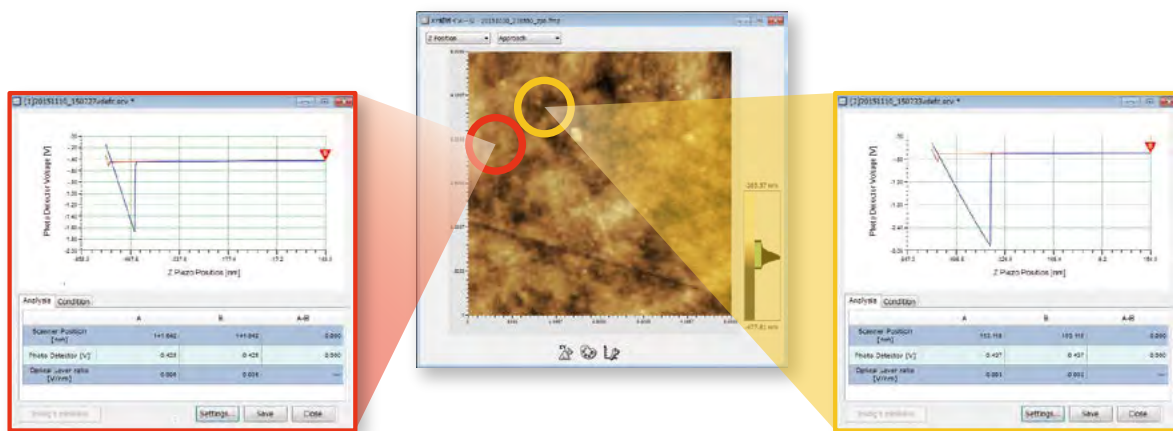

Force curves were measured at arbitrary points on a film surface. The results show that the adhesive force is different at the respective points.

Similarly, physical properties can also be evaluated on small soft samples, such as biopolymers.

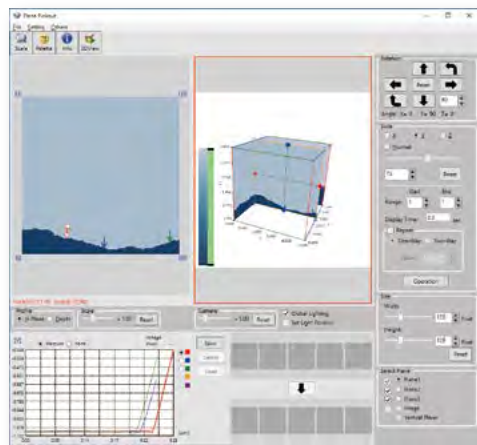

### • 3D Analysis

All force curves acquired for mapping are saved. Therefore, the data can be displayed three-dimensionally, or specific cross sections can be extracted for data analysis.

# Mapping the Physical Properties of Plastic Films

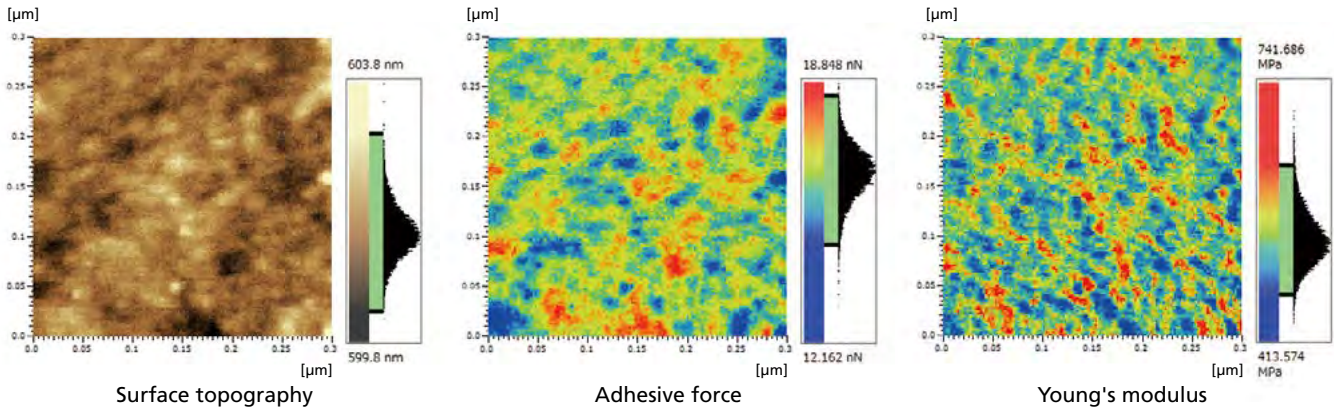

Mapping analysis can be used to measure adhesive force and Young's modulus as well as surface topography. The figure shows a quantitative visualization of the Young's modulus within a localized area only 300 nm wide on a plastic film surface. (Sample source: MORESCO).

**Application example** Evaluating the uniformity of a polymer material surface

## Adhesive Part of an Adhesive Tape

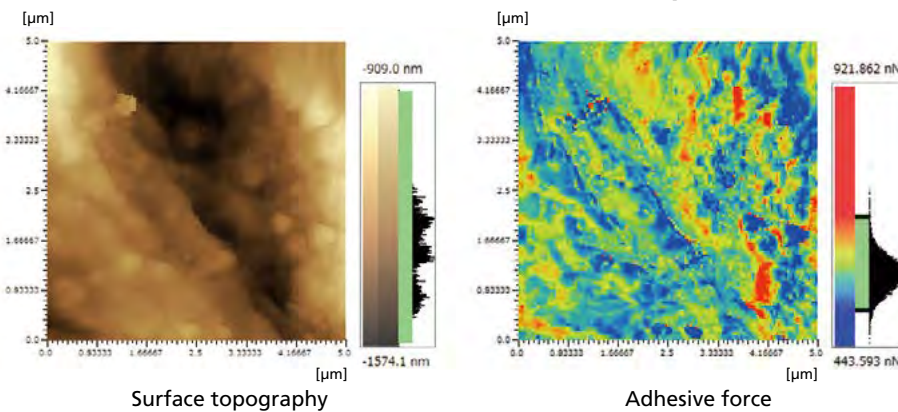

These images are from an evaluation of the adhesive part of an adhesive tape. They show that the adhesive force is distributed non-uniformly. This demonstrates how the system can be used to evaluate adhesive properties, which were difficult to evaluate using conventional methods.

**Application example** Evaluating the localized adhesive properties of thin films.

## Main Specifications

### Force Curve

Measurement	Scan (Z) range	Settings method	Specify end point and width, and automatically track end point
		Range	Depends on scanner
	Scanning speed	Frequency setting	0.1 to 100 Hz
		Frequency setting step size	0.1 Hz
XY movement	Settings method	Numerical entry, or specified with mouse on SPM image	
	Range	Depends on scanner	
Display	SPM image data, force curve waveform, measurement parameters, and data analysis results		

### Mapping

Measurement	Physical quantities measured	Adsorption force, slope of force curve, Z-position, or elastic modulus
	Range	Depends on scanner
	Resolution	512x512, 256x256, 128x128, 64x64, 32x32, 16x16, 8x8, 4x4, 2x2
Display	SPM image data, force curve waveform, and measurement parameters	

# Wide Variety of 3D Rendering Functions Using Mouse Operations

Use the mouse to freely rotate images, zoom, or change the Z-axis magnification. This enables expressing image data in a variety of ways while confirming the data in real time.

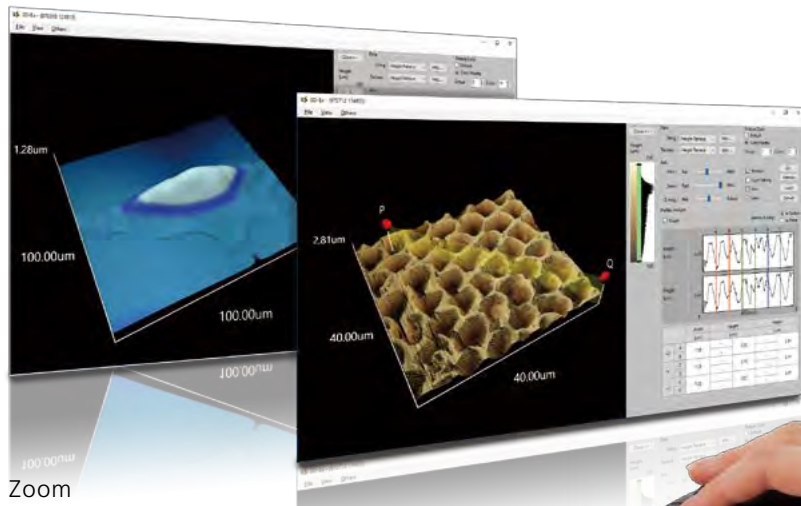

Zoom

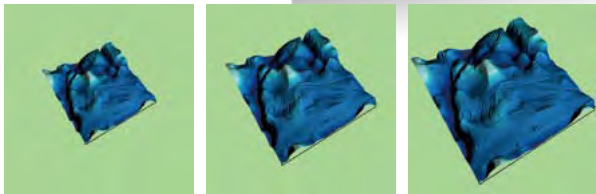

Rotation

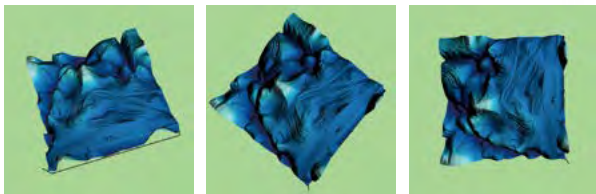

Change Z-Axis Magnification

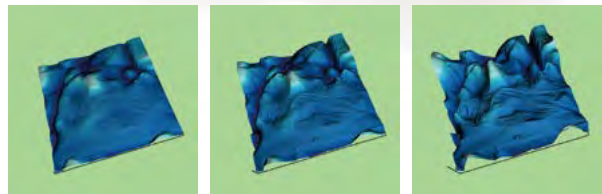

## Texture Function

Height information can be displayed overlaid with information about other physical properties. This allows clearly showing the relationship between both parameters.

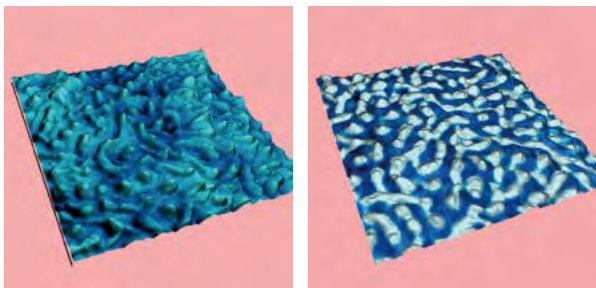

3D Image

Overlay of Topographic Image and Phase Image

## 3D Cross-Section Profile Analysis

Cross-section profiles can be analyzed in 3D images. If physical property information is expressed in terms of texture, respective cross-section profiles can be displayed and analyzed in the same location.

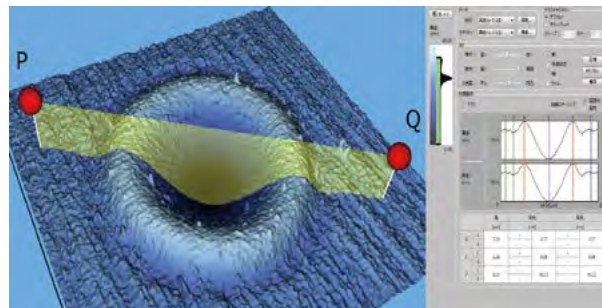

# Particle Analysis Software (option)

The particle analysis software extracts multiple particles from SPM-9700 image data and calculates feature values for each particle, then analyzes and displays them. This is especially useful for processing data statistically. The following wide selection of feature values and their corresponding statistical quantities can be calculated, tabulated, sorted, or graphed. Numerical data can be exported.

## Feature Parameters

- |                                   |                             |
|-----------------------------------|-----------------------------|
| 1 Center X                        | 16 Average Z                |
| 2 Center Y                        | 17 Average Round Z          |
| 3 Maximum Diameter                | 18 Area excluding Holes     |
| 4 Pattern Width                   | 19 Area including Holes     |
| 5 Horizontal Feret Length         | 20 Surface Area             |
| 6 Vertical Feret Length           | 21 Volume                   |
| 7 Radius as Circle excluding Hole | 22 Pattern Direction        |
| 8 Radius as Circle including Hole | 23 2nd Moment Direction     |
| 9 Mean Radius                     | 24 Area / Feret Area        |
| 10 Mean Radius Variance           | 25 Particle Area / All Area |
| 11 Nearest Distance               | 26 Distortion               |
| 12 Perimeter                      | 27 Circular Degree          |
| 13 C Perimeter                    | 28 Roughness                |
| 14 Maximum Z                      | 29 Thin Degree              |
| 15 Minimum Z                      |                             |

## Statistical Values

- 1 Average
- 2 Standard Deviation
- 3 Line Average
- 4 Square Average
- 5 Cubic Average
- 6 Sum
- 7 Maximum
- 8 Minimum
- 9 Maximum Label
- 10 Minimum Label
- 11 Range
- 12 Samples

## Analysis Example

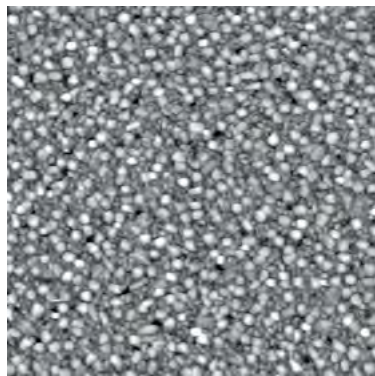

Thin Film (5 μm square)

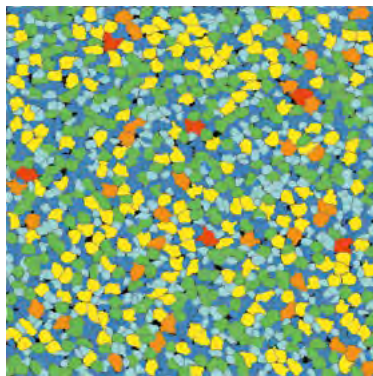

Particle Extraction and Classification Results

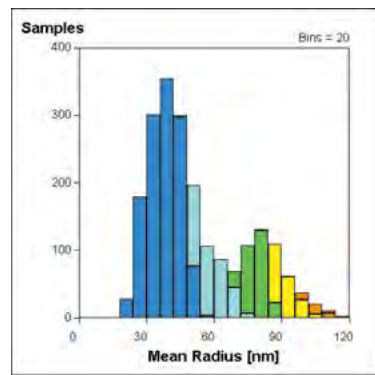

Histogram of Mean Radius

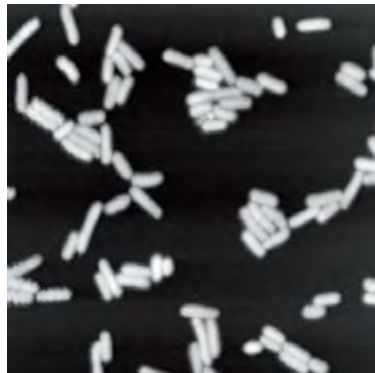

*E. Coli* Bacteria (30 μm square)

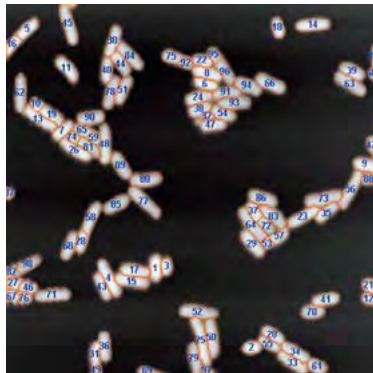

Particle Extraction and Labeling Results

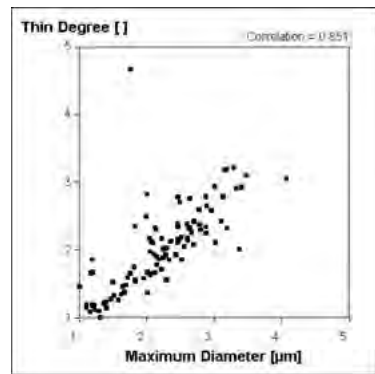

Graph of Correlation Between Maximum Diameter and Thin Degree



# SPM Data Room Website

The SPM Data Room website includes examples of new observation data, applications, a list of scientific articles, and a list of presentations.

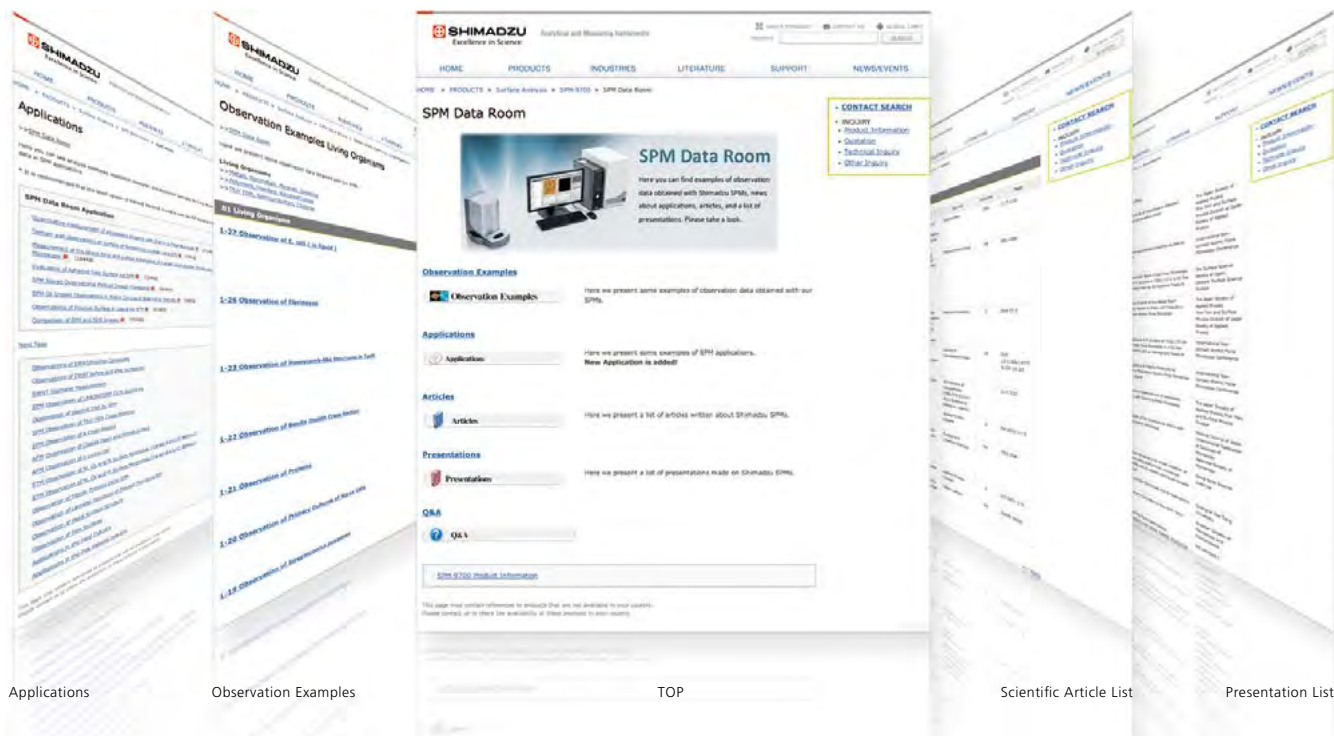

<http://www.shimadzu.com/an/surface/spm/dataroom.html>

SPM Data Room

Search

## 01 Living Organisms

*E. coli* Bacteria

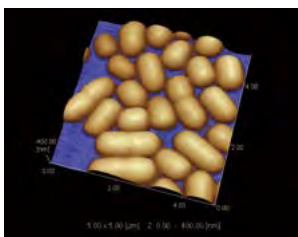

*E. coli* bacteria were dried on a substrate and observed in liquid media. (Data provided by Ms. Ikemoto and Dr. Kogure, Atmosphere and Ocean Research Institute, The University of Tokyo)

## 03 Non-Metals

Ferroelectric Domains

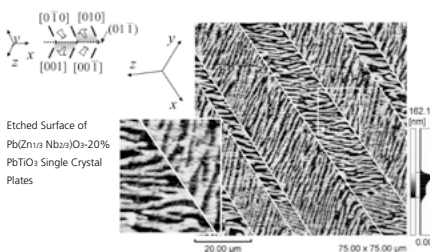

By etching the surface, the domain wall structure of ferroelectric crystal surfaces can be observed. (Data provided by Dr. Iwata, Faculty of Engineering, Nagoya Institute of Technology)

## 02 Metals

Boundary Surface of Plating Layer

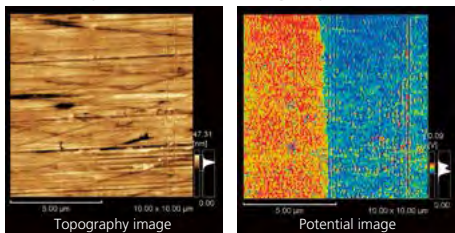

A cross-section of a copper (Cu) plated iron (Fe) sample was prepared, and the electric potential measured along the boundary surface. The topographic image on the left does not show any change in thickness, but the electric potential image on the right shows that the iron portion has a potential that is about 90 mV higher.

## 04 Minerals

### Observation of Calcite in Solution

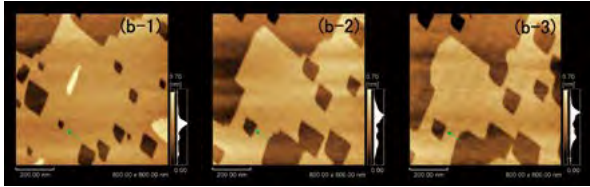

The crystal dissolution process of calcite in solution was observed. Propagation steps of about 0.3 nm, due to dissolution, were observed. About 10 minutes elapsed between (b-1) and (b-3).

(Data provided by Dr. Kagi, School of Science, The University of Tokyo)

## 05 Ceramics

### Film Dispersed with Silica

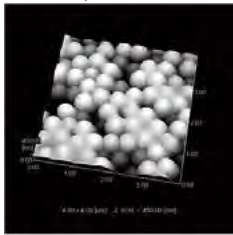

Film material with mono-dispersed spherical silica dispersed in an organic binder. This clearly shows how the binder binds the spherical particles.  
(Data provided by Japan Fine Ceramics Center (JFCC))

## 06 Polymers

### Li-Ion Battery Separator

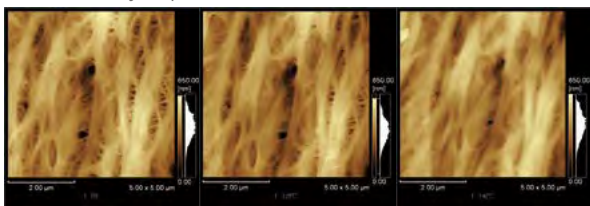

Room Temperature      125 °C      140 °C

The separator surface was observed after removal from the lithium-ion battery. Heated observation shows how the fiber swells at high temperatures and fills the pores.

## 07 Powders

### Toner Particle

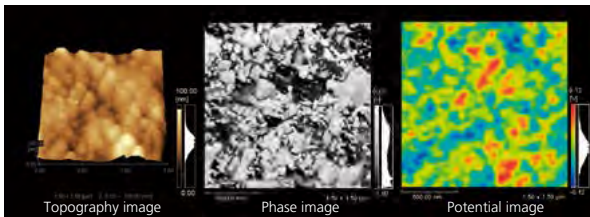

The top part of one toner particle was observed at high magnification. A topographic image of the surface is shown on the left. Phase and surface potential (KFM) images are shown on the right. The images on the right show how comparing images of different properties in the same field of view allows correlating the distribution of toner material and external additives with the corresponding electric potential distribution.

## 08 Nanotechnology

### Rendering Images Using Electric Potential

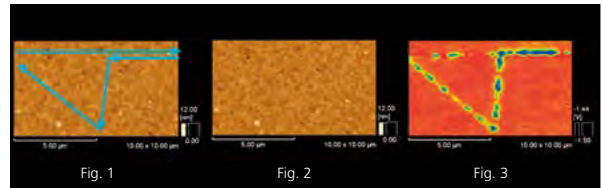

Vector scanning was used on a gold vapor deposition surface on a silicon substrate to render the trace shown in Fig. 1. A conductive cantilever was used to apply a tiny electric potential between the sample and probe. After rendering, simultaneous AFM and KFM measurements showed no change in the shape of the AFM image (Fig. 2), but the potential measured along the trace in the KFM image (Fig. 3) was about 50 mV lower than the surrounding area.

## 09 Thin Films

### Cross-Section of Thin Film

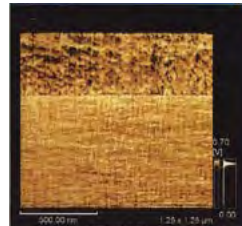

A cross-section of an organic thin film vapor-deposited on a silicon substrate was observed with the SPM by turning the sample so the cut edge faced upward.

The boundary can be clearly observed. This shows that about the top 1/3 is the organic film layer, which is 390 nm thick. This application example is only possible because of the stable probe control provided by the SPM-9700HT.

## 10 Semiconductors

### Electric Potential Analysis of Organic Thin Film Transistor (FET)

This is an example of analyzing the shape and electric potential of organic thin film transistors, which have gained attention for their use in flexible displays and other applications. The film material is P3HT (3-hexylthiophene), which provides high electron mobility. To use the SPM for actual measurement, the source electrode was grounded and an electric potential was applied independently to the gate and drain electrodes, then the variation in surface potential on the gate was determined.  
(Data provided by Dr. Fukuda, Department of Information and Electronic Engineering, Muroran Institute of Technology)

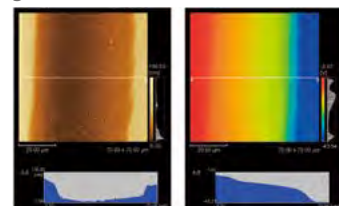

## 11 Coatings

### Baking Finished Surface

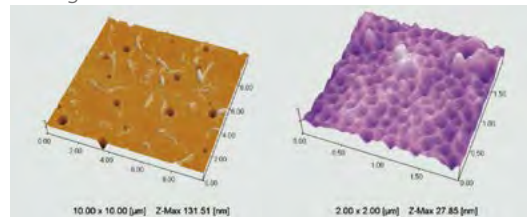

The coated surface shows many holes from outgassing. The metallic painted surface (left) shows it contains metal fibers.

# SPM-9700HT Scanning Probe Microscope

## SPM Unit

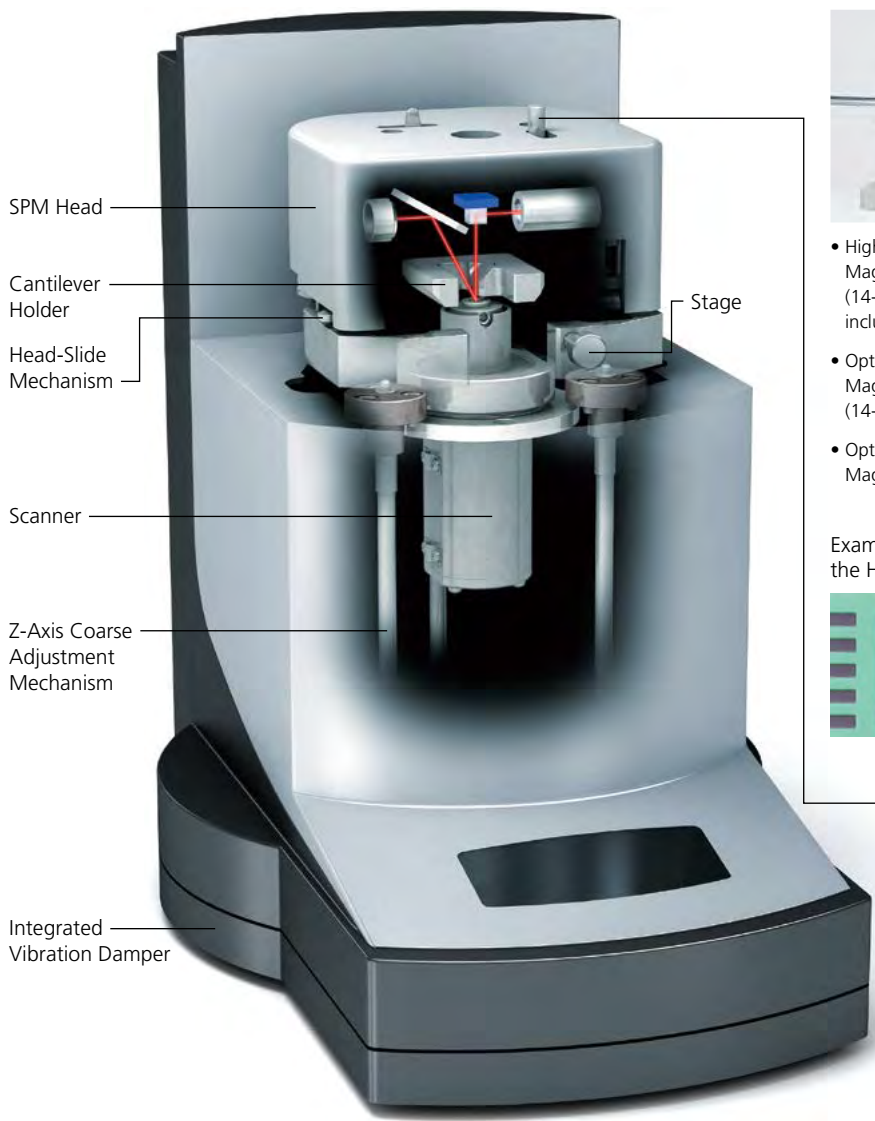

### Example of Optical Microscope Setups



- High Magnification Optical Microscope Unit (with CCD)  
Magnification of Display Monitor: 48x to 900x zoom  
(14-inch display mode)  
including coaxial epi-illumination
- Optical Microscope Unit (with CCD)  
Magnification of Display Monitor: 100x  
(14-inch display mode)
- Optical Microscope Unit (without CCD)  
Magnification: 40x (20x ocular and 2x objective)

### Example of Observing a Sample and Cantilever Using the High Magnification Optical Microscope Unit



The splitter slide mechanism enables obtaining a bright optical microscope image.  
Field-of-View: 270  $\mu\text{m}$   $\times$  180  $\mu\text{m}$   
Cantilever: NCH

### Splitter-Slide Mechanism



(Japanese Patent No. 4032272)

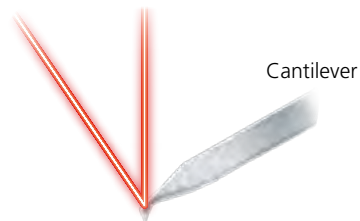

### Specifications for SPM Unit

Resolution	XY: 0.2 nm, Z: 0.01 nm	
Max. Scanning Range (X, Y, Z)	HT Scanner Unit	X-Y: 10 $\mu\text{m}$ Z: 1 $\mu\text{m}$ (standard)
	Middle Range Scanner Unit	X-Y: 30 $\mu\text{m}$ Z: 5 $\mu\text{m}$ (optional)
	Wide Range Scanner Unit	X-Y: 125 $\mu\text{m}$ Z: 7 $\mu\text{m}$ (optional)
	Deep-type Scanner Unit	X-Y: 55 $\mu\text{m}$ Z: 13 $\mu\text{m}$ (optional)
	Narrow Range Scanner Unit	X-Y: 2.5 $\mu\text{m}$ Z: 0.3 $\mu\text{m}$ (optional)
Stage	Max. sample size: 24 mm dia. $\times$ 8 mm (stage for $\phi$ 35mm or $\phi$ 50mm are available as a special order item) Sample replacement method: Head-slide mechanism with integrated displacement detection system and cantilever Samples can be replaced without removing cantilever. Sample securing method: Secured with magnets	

### Consumable Parts

Cantilever for contact mode	SiN	Set of 34 chips
Cantilever for dynamic mode	Si	Set of 20 chips
Cantilever for magnetic force mode (MFM)	Si	Set of 20 chips
Cantilever for current mode	Si	Set of 20 chips
Cantilever for surface potential mode (KFM)	Si	Set of 20 chips

\* Many other types of cantilevers are also available. Contact your Shimadzu representative for details.

## Standard Functions

### Contact Mode

This mode creates an image of displacement in the sample height direction by scanning the sample surface with the repulsive force acting between the cantilever tip and sample kept constant.

Force curves can be measured as well.

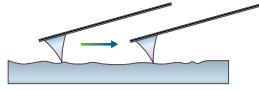

### Lateral Force Mode (LFM)

By detecting the amount of twist in the cantilever during contact mode scanning, an image can be created from information corresponding to lateral forces (friction) acting between the sample and cantilever.

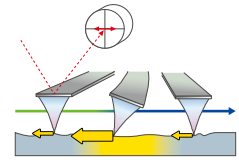

### Dynamic Mode

This mode vibrates the cantilever near its resonant frequency. Since the amplitude changes as the cantilever approaches the sample, a sample height displacement image can be created by moving the probe to keep the amplitude constant.

Force curves can be measured as well.

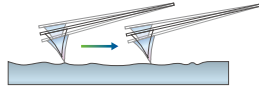

### Force Modulation Mode

This mode vibrates the sample at constant amplitude and frequency during contact mode scanning. The cantilever response is detected by separating it into its amplitude and phase components. This allows creating an image of differences in sample surface properties.

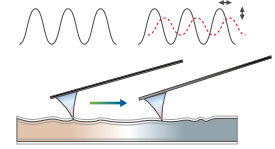

### Phase Mode

This mode detects the phase shift delay in the cantilever vibration during dynamic mode scanning. This allows creating an image of differences in sample surface properties.

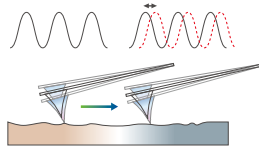

## Optional Functions

### Current Mode

This mode applies a voltage between a conductive cantilever and sample during contact mode scanning and creates an image from the distribution of current flows.

I/V measurement is also possible.

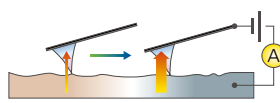

### Nano 3D Mapping

A force curve can be measured for each point in observed image data to observe a distribution of sample mechanical properties or adhesive strength.

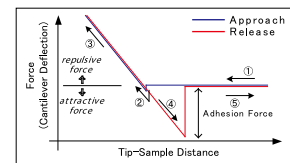
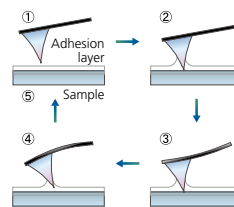

### Surface Potential Mode (KFM)

An image can be created from the electric potential of the sample surface by applying an alternating current electrical signal to a conductive cantilever and detecting the static electric force acting between the sample surface and cantilever.

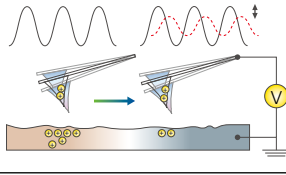

### Magnetic Force Mode (MFM)

This mode scans the sample with a magnetic tipped cantilever kept at a constant distance from the sample. An image can be created from magnetic information of the sample surface obtained by detecting the magnetic force from the magnetic leakage field.

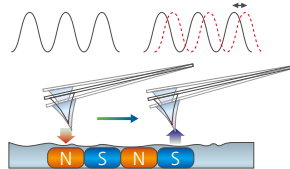

### Petri Dish Type Solution Cell (special order)

The sample is attached to the bottom of a small petri dish, which is then filled with solution. By scanning with the cantilever immersed in solution, AFM observations can be performed in solutions.

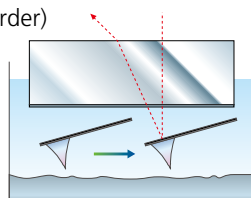

### Electrochemical Solution Cell

This cell is used for AFM observations of sample surface changes while an electrochemical reaction occurs in an electrolytic solution. The cell includes three standard electrodes (working, counter, and reference) and includes a petri dish type solution cell.

(Does not include the separately-ordered electrochemical controller (potentiostat).)



# Environment Controlled Scanning Probe Microscope WET-SPM Series



## SPM Observations in a Controlled Environment

By adding an environment controlled chamber, the SPM-9700 scanning probe microscope can be upgraded to a WET-SPM series system. This is only possible for the SPM-9700, which was optimized for operating within a controlled chamber, by including features such as a Shimadzu proprietary head-slide mechanism, operation from the front panel, fully automatic approach, and open head design.

This is especially ideal for samples vulnerable to air or moisture.



## Environment Controlled Chamber CH-II / CH-III

These environment controlled chambers, CH-II (without TMP) and CH-III (with TMP), were designed specifically for the SPM-9700 series as a chamber system with a built-in vibration damper. Since this enables controlling both the sample and surrounding environment, the SPM can be used to directly observe samples processed in a controlled environment (Japanese Patent No. 2612395, US Patent No. 5200616). A large view port and dual glove ports allow pretreating samples inside the chamber. Adding the option for in-situ SPM permits real-time investigation of surface changes due to changes in physical parameters such as temperature, humidity, pressure, luminescence, and concentration. The SPM unit can be easily loaded into and unloaded from the chamber from the rear, allowing it to be used for both ambient atmosphere and controlled environment observations.

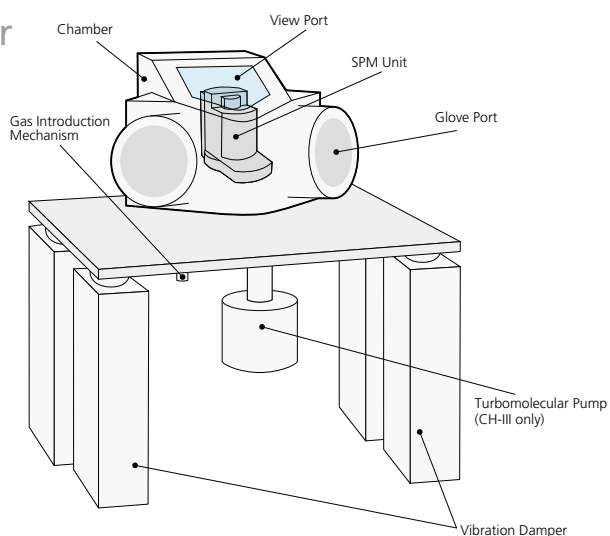

Photo of Front

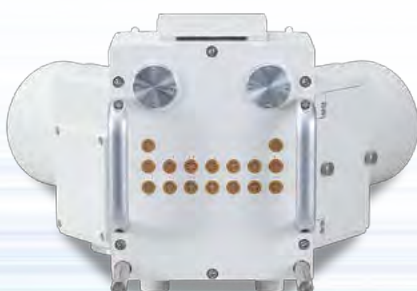

Photo of Back

### Specifications

Port	Glove port	2
	Large view port	1
	Unit loading port	1
	Sample loading port	1
	Pumping port	1
	Spare port	4
Pumps Used for Vacuum System	Rotary pump (160 L/min) Turbomolecular pump (50 L/sec) (CH-III only)	
Gas Introduction Mechanism	Single-circuit automatic control	
Current Input Terminals (7-pin)	16 (including spares)	
Vibration Damper	Integrated air-spring vibration damper	

# WET-SPM Series Options

## Temperature and Humidity Controller

Controller is attached to an environment controlled chamber to control the temperature and humidity inside the chamber.



Humidified Gas Generator

## FC Film Observation with Environmentally Controlled Temperature and Humidity

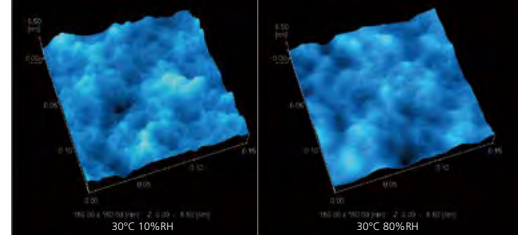

Low Temperature

High Temperature

Variations in the surface shape of Nafion film due to changes in humidity were observed.

In each case, microscopic features of about a few nm in height were observed, but the images show that increasing the humidity results in smoother features and more swelling.

## Polymer Film

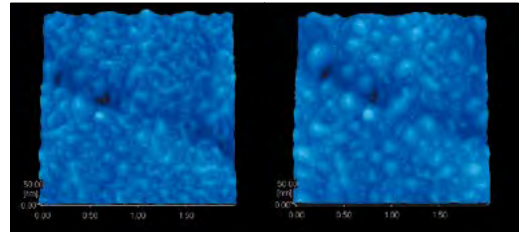

Low Temperature

High Temperature

Variations in the shape of polymer film were observed using a controlled temperature and humidity environment.

## Gas Spray Unit

The gas spray unit is attached to a spare port to spray small amounts of gas on the sample.



## Real Time Observation of Nickel Surface Variations

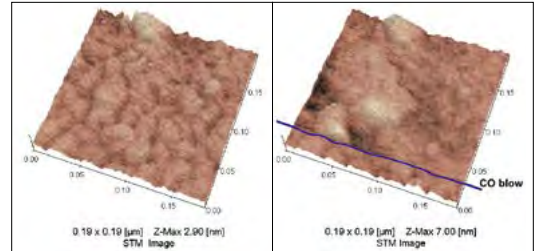

The nickel surface's reaction to gas was observed continuously in real time. When the clean surface after reduction (left) started being sprayed with carbon monoxide, the change in shape was observed as carbonyl complexes were formed (right).

(Data provided by former National Institute of Materials and Chemical Research)

## Sample Heating and Cooling Unit

The sample can be loaded into the unit and heated or cooled.



## Observation of Cooled Plastic

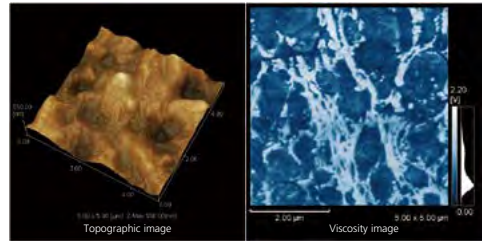

Room Temperature

Two separate phases were observed in the viscosity image.

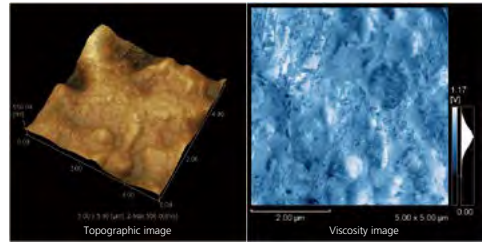

Cooled to  $-30^{\circ}\text{C}$

After cooling, there were almost no visible differences in viscosity.

## Sample Heating Unit

The sample can be loaded into the unit and heated. The unit can even be operated in atmospheric conditions, depending on the sample.



Temperature Controller

Heated Holder Installed in Scanner

## Observation of Heated Polymer Film

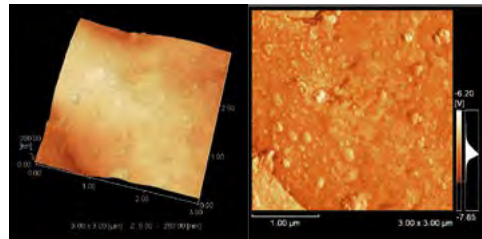

$30^{\circ}\text{C}$

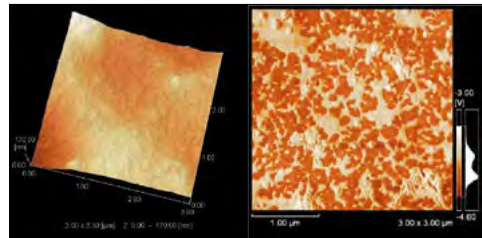

$50^{\circ}\text{C}$

The phase image (right) clearly shows the changes in sample surface physical properties as the sample is heated.

## Light Irradiation Unit

This unit enables the use of a fiber optic light to irradiate sample surfaces. It does not include the light source or the optical fiber. It can be operated in atmospheric conditions.



## Observation of Ultraviolet Light Irradiating Pentacene Thin Film on $\text{SrTiO}_3$

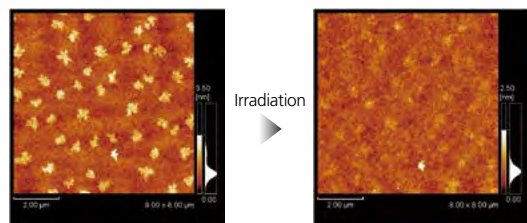

Before Irradiation

40 Minutes After Irradiation

The pentacene thin film was formed as a cluster of two or three 1.6 nm thick layers. When irradiated with 365 nm wavelength ultraviolet light, the cluster structure gradually started breaking apart. After 40 minutes, the thin film cluster was mostly gone. During this time, there is negligible drift and observation is possible using the same field of view.

(Data provided by Dr. Yuji Matsumoto, Frontier Research Center, Tokyo Institute of Technology)



# Specifications

## 1. SPM Unit

Observation Modes	Standard	Contact Dynamic Phase Lateral Force (LFM) Force Modulation
	Optional	Magnetic Force (MFM) Current Surface Potential (KFM)
Resolution	X, Y	0.2 nm
	Z	0.01 nm
SPM Head	Displacement detection system	Light source/Optical lever/Detector
	Light source	Laser diode (ON/OFF) Irradiates cantilever continuously, even while replacing samples.
	Detector	Photodetector
Scanner	Drive element	Tube piezoelectric element
	Max. scanning size (X, Y, Z)	10 $\mu\text{m}$ $\times$ 10 $\mu\text{m}$ $\times$ 1 $\mu\text{m}$ (standard) 30 $\mu\text{m}$ $\times$ 30 $\mu\text{m}$ $\times$ 5 $\mu\text{m}$ (optional) 125 $\mu\text{m}$ $\times$ 125 $\mu\text{m}$ $\times$ 7 $\mu\text{m}$ (optional) 55 $\mu\text{m}$ $\times$ 55 $\mu\text{m}$ $\times$ 13 $\mu\text{m}$ (optional) 2.5 $\mu\text{m}$ $\times$ 2.5 $\mu\text{m}$ $\times$ 0.3 $\mu\text{m}$ (optional)
Stage	Max. sample size	24 mm dia. $\times$ 8 mm
	Sample replacement method	Head-slide mechanism with integrated displacement detection system and cantilever Samples can be replaced without removing cantilever.
	Sample securing method	Magnet
Z-Axis Coarse Adjustment Mechanism	Method	Automatic, using stepping motor Fully automatic, regardless of sample thickness
	Max. stroke	10 mm
Signal Display Panel	Displayed quantity	Total incident light to detector (digital display)
Vibration Isolation System	Vibration Damper	Built into SPM unit
Optical Microscope Observation	Method	Beam-splitter slide mechanism
Specialized enclosure	Method	Not necessary or environment controlled chamber is used.
Environment Control	Method	Chamber can be added without modifying SPM unit.

## 2. Control Unit

Scan Controller	XY-axis control	$\pm 211$ V, full time 16-bit accuracy
	Z-axis control	$\pm 211$ V, max. 26-bit accuracy
Feedback Controller	Control system	Digital control by DSP
Data Acquisition Controller	Input signal	5 channels (standard) 7 channels (optional)
Communications Interface	Protocol	TCP/IP

## 3. Data Processing Unit

Host Computer	Operating system	Windows 10 Pro (64 bit), English version
	Storage	HDD 160 GB min. CD-RW drive
Monitor	Panel	Flat panel display Display resolution : 1920 $\times$ 1080 pixels
Communications Interface	Protocol	TCP/IP

## 4. Software

Online	Input Signal	Select from up to 6 signals.
	Image data display	Maximum 8 images can be displayed simultaneously.
	Scanning direction	Trace/retrace (simultaneous observation possible) Angle setting can be changed.
	Scanning size	0.1 nm to max. scanning size (depending on scanner type) Offset setting can be changed.
	Number of pixels	2048 $\times$ 2048, 1024 $\times$ 1024, 512 $\times$ 512, 256 $\times$ 256, 128 $\times$ 128, 64 $\times$ 64, 32 $\times$ 32
	Data size	Approx. 16 MB to 64 KB/data
	Observation window	Multiple frames display: 1 frame, frames, 2 frame, frames (Vertical or Horizontal), or 4 frame, frames Z-axis display range settings (display range, offset) Color palette settings (400 types) Tilt correction setting Image history display modes (list, single screen)
	Profile display	Display cross-section profile during scanning, and save (both directions). Display cross-section profile at scanning position, analyze profile between any two points.
	Status display	Display the operating status of the main unit.
	Preset	Register and retrieve parameter settings.
	Calibration	Independent calibration of each axis (X, Y, and Z)
	Scanning	Switch XY-scanning ON/OFF Switch Y-scanning ON/OFF Y-scanning can be restarted. Y-scanning start position can be changed (top, center, or bottom).
	Signal display	Display detector vertical/horizontal variation signal. Display feedback signal. Display laser intensity.
	Offline	Navigator
Image history		Display list of saved images or display saved images. Display cross-section profile or analyze profile between any two points.
Guidance		Display operating procedures.
Browser		List in thumbnail mode Delete, copy, move, or search data. Change group names or data names. Create/delete folders.
Image data display		Variable shade image (top view) display (length measurement possible) Pseudo-3D display, 3D display Zoom in/out or rotate 3D display (mouse operation possible) Analyze cross-section profile of 3D display. Set light source, view angle, and gloss settings for 3D-image display. Display contour lines. Create, edit, and select color palettes. Change Z-axis range setting, set Z-axis units. Reduce/enlarge image, create as icon. Display image data information (parameters, image processing history, comments). Enter and display comments.
Line data display		Overlay, tile, overwrite. Line colors can be changed. Reduce/enlarge image, create as icon.
Image data processing		Flatten, erase noisy lines. Local filter, spectrum filter Zoom, invert, and rotate image. Resample, extract lines, use macro functions.
Image data analysis		Profile analysis, line roughness analysis. Surface roughness analysis, topography analysis, step measurement. Power spectrum analysis, autocorrelation analysis Fractal analysis, line length analysis, line roughness analysis
File output		DIB format (bitmap) TIFF format, ASCII format



# Installation Specifications

## ● Installation Environment

The following conditions are appropriate for the room where the SPM is installed.

Temperature : 23 °C ± 5 °C  
Relative Humidity : 60 % max.

## ● Power Supply

The following power supply is required to operate the SPM-9700HT.

### SPM-9700HT

Single-phase 100 – 120 V / 200 – 240 V, 50/60 Hz, 15 A - 2 circuits  
Grounding Resistance: 100 Ω max.

\* The power supply indicated above is for a basic configuration of the SPM-9700HT and can vary depending on the options included. Please see specifications for details.

### Environment Controlled Chamber

Single-phase 100 – 120 V, 50/60 Hz, 15 A - 2 circuits  
Grounding Resistance: 100 Ω max.

## ● Size and Weight of Units

SPM Unit	W180 × D255 × H260 mm	5.5 kg
Controller	W250 × D420 × H454 mm	18.5 kg
Environment Controlled Chamber	W1170 × D725 × H1055 mm	210 kg



## Installation Example \* Figure shows example of one possible configuration.

### SPM-9700HT

Front View

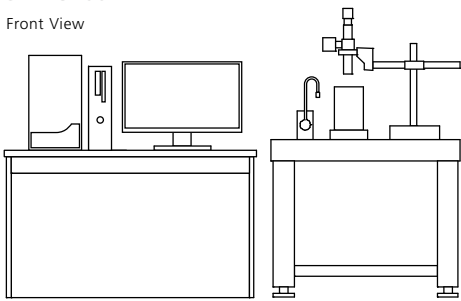

Top View

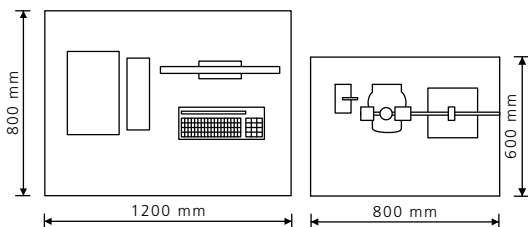

\* Dimensions for the computer table and desk-type air-spring vibration damper are only indicated for reference purposes.

### WET-SPM

Front View

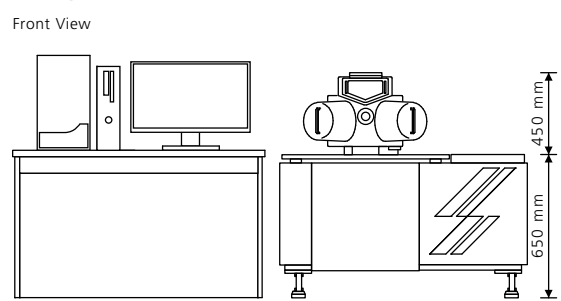

Top View

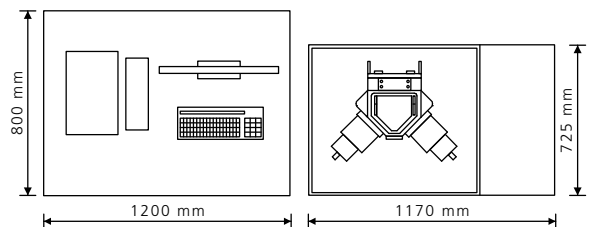

\* Dimensions for the computer table are only indicated for reference purposes.



Shimadzu Corporation  
[www.shimadzu.com/an/](http://www.shimadzu.com/an/)

**For Research Use Only. Not for use in diagnostic procedures.**

This publication may contain references to products that are not available in your country. Please contact us to check the availability of these products in your country.

Company names, products/service names and logos used in this publication are trademarks and trade names of Shimadzu Corporation, its subsidiaries or its affiliates, whether or not they are used with trademark symbol "TM" or "®".

Third-party trademarks and trade names may be used in this publication to refer to either the entities or their products/services, whether or not they are used with trademark symbol "TM" or "®".

Shimadzu disclaims any proprietary interest in trademarks and trade names other than its own.

The contents of this publication are provided to you "as is" without warranty of any kind, and are subject to change without notice. Shimadzu does not assume any responsibility or liability for any damage, whether direct or indirect, relating to the use of this publication.